

Mass Flow Meter

MF5700 Series

User Manual

(VB.2)



Please read this manual for ensuring correct use of this product. Make the manual available for easy access.

METERY TECHNOLOGY CO., LTD

Flow Meters

MF5700 Series

User Manual

Document No. 05-2016-M5 EN

Issue date: 2016.05

Revision: VB.2

RESTRICTION ON USE

1. This meter is manufactured for general purpose industrial applications for flow measurements. Do not alter any hardware and software of the product. Any modifications might cause damage and unexpected events.
2. All practices for electronic device safety should apply.
3. Do not use this product in any environments where human safety may be at risk.
4. Only a qualified person from Siargo or a person who is accredited by Siargo can perform troubleshooting services to the product, Siargo is otherwise not liable for any consequences thereafter.

SAFETY PRECAUTION

1. The product can be utilized to measure and/or monitor in-line mass flow rate of any clean, dry and preferably gases with constant concentration in industrial applications. For other special gases or variable concentration gases, the product may not function properly or even can be damaged. Please contact Siargo for further information.
2. The operational environments of the product are illustrated in the section of product specifications. If the product is used for other circumstances, the product may not function properly or even can be damaged.
3. Operation, installation, storage, and maintenance of the product must strictly follow the instructions illustrated in this user manual. Otherwise, unpredicted damage and even injuries or other severe situations could be induced. All the installation, storage, and maintenance of the product must be performed by skilled workers. This user manual should be placed near the product for easy access.
4. Before using the product, the user should read this user manual completely and in details so that the user is well understand all the important instructions.
It is recommended that the product should be re-calibrated and serviced in every two years or at a time of desire.

Contents

RESTRICTION ON USE	i
SAFETY PRECAUTION	i
Contents	ii
Features	1
Applications	1
Working Principle	2
Control Schematics	2
Specifications	3
Dimension	4
Product Selection	4
Installation	5
Menu Operation	7
Communication	11
Parts in Package	12
Safety and Maintenance	12
Customer Service	13

Siargo designs, develops and manufactures the world leading MEMS mass flow sensing products for various applications in gas flow monitor, measurement and control. This manual provides the instructions for proper use of the MF5700 series of products, including installation, maintenance and troubleshooting. For further customization or other product related questions, please contact the manufacture or visit www.Siargo.com

Features

- ✎ Highly accurate thermal mass flow sensing
- ✎ Automatic temperature and pressure compensation
- ✎ High sensitivity for trace flow measurement
- ✎ Excellent turndown of 50:1 or over
- ✎ Support multiple gas measurements and customizable online calibration
- ✎ Instant flow rate and accumulated flow rate with temperature sensing
- ✎ Remote communication with RS485 Modbus
- ✎ Meter configuration and data access with front keyboard
- ✎ Customer configurable alarm for over range or limit
- ✎ Portability design with options of battery operation or external power
- ✎ Rotatable meter head with standard NPT or customizable connectors

Applications



Mechanics



Food



Tobacco



Chemistry



Beverage



Glass



Agriculture



Research



Pharmaceutics



Instrumentation

Working Principle

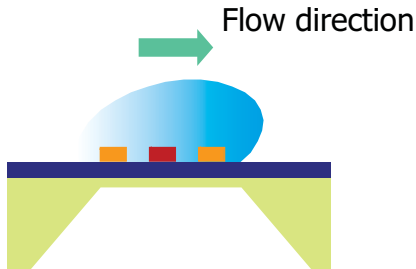

MF5700 series flow meters measure flow using Siargo’s proprietary MEMS calorimetric mass flow sensor that is installed in the flow channel forming a plate that serves as an additional flow conditioner from the boundary layer configuration resulting in a laminar flow. The mass flow measurement is established as the fluid carries heat away from the heater causing the redistribution of the temperature field. Accurate flow rate is obtained by calibration with the standard fluid at the preset conditions.

Control Schematics

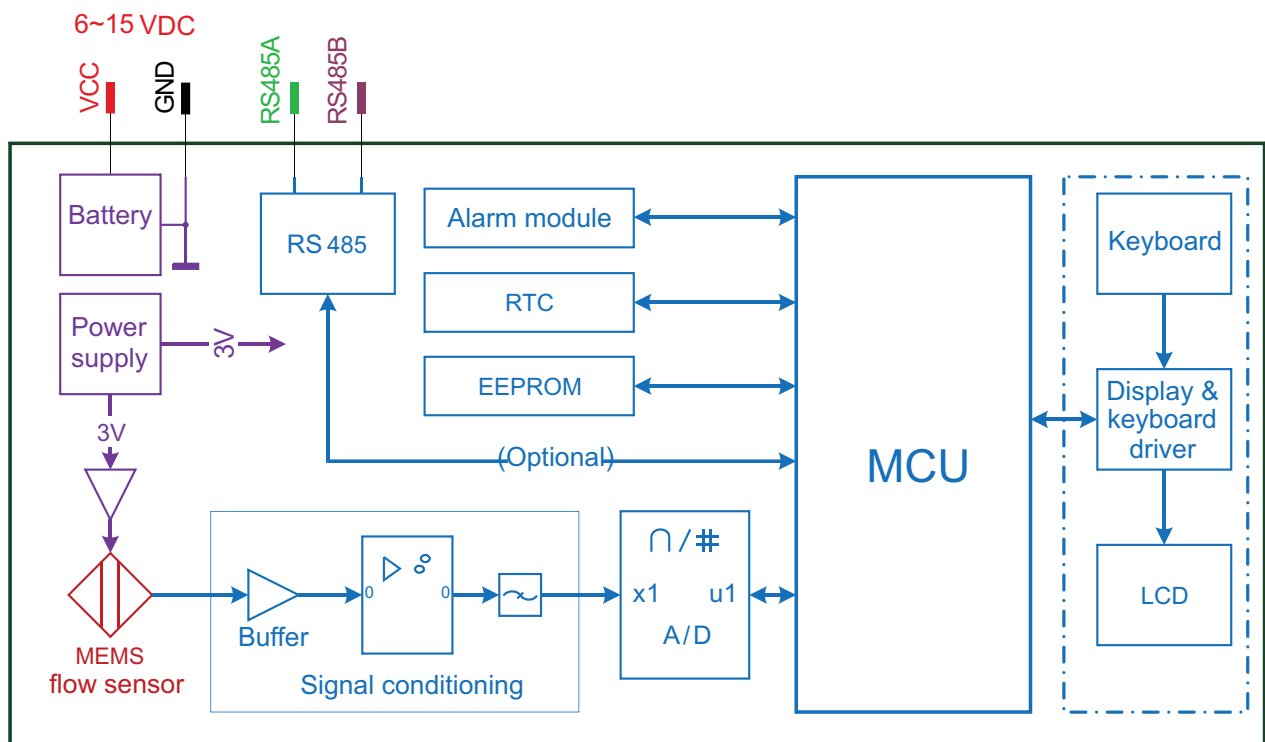

Specifications

	MF5706	MF5712	
Flow range	0~10, 25	0~200	SLPM
Turn-down ratio	30:1		%
Accuracy	$\pm(2.0+0.5FS)$		%
Repeatability	0.5		%
Response time	≤ 2		sec
Power supply	4 AA batteries (LR6) / 6 ~ 15 Vdc (with 220 Vac adaptor)		
Output	RS485 Modbus (Optional)		
Display	LCD		
Display information	Instant flow: SLPM; Accumulated flow: NCM; Battery status		
Display Instant flow rate resolution	0.01	0.1	SLPM
Flow accumulation	0.001		NCM
Continuous working time	> 60 days (with batteries)		
Max. pressure	≤ 0.8		MPa
Pressure loss	≤ 600	≤ 2000	Pa
Working temperature	-10 ~ 55		°C
Storage temperature	-20 ~ 65		°C
Humidity	< 95%RH (No icing or condensation)		
Keyboard	3 keys		
User function	Password; alarm limit; accumulated flow; zero reset		
Calibration gas	N ₂ @ 20 °C, 101.325 kPa		
User interface	miniUSB		
DN	6.0	12.0	mm
Mechanical connection	NPT 1/4"	NPT 1/2"	
Weight	350		g

*Meter head can be rotated 180 degree for convenience at installation.

Dimensions

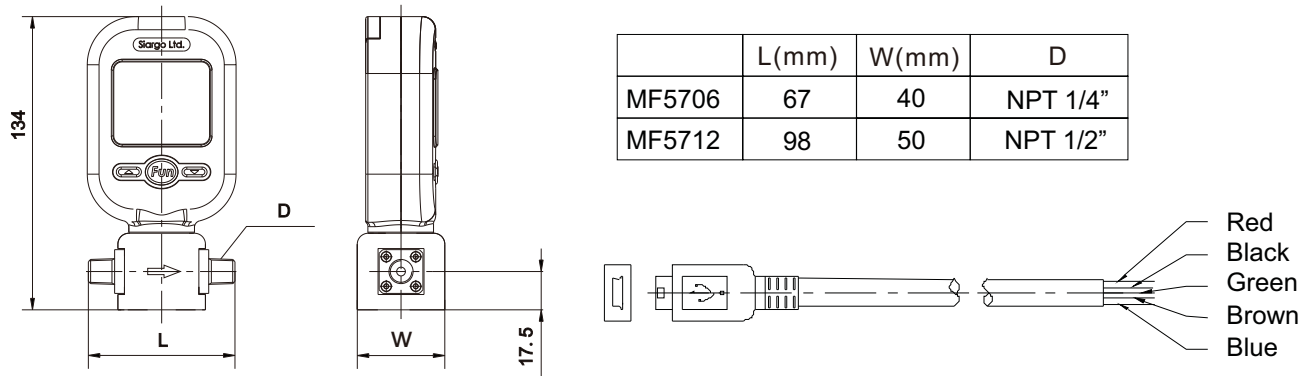

Note:

- 1) Please note the flow direction should be the same as that indicated by the arrow on the meter body, otherwise the reading will be null.
- 2) The optional miniUSB cable will provide connections to external power supply as well as the RS485 communication. For connection definitions, see 8.1.

Product Selection

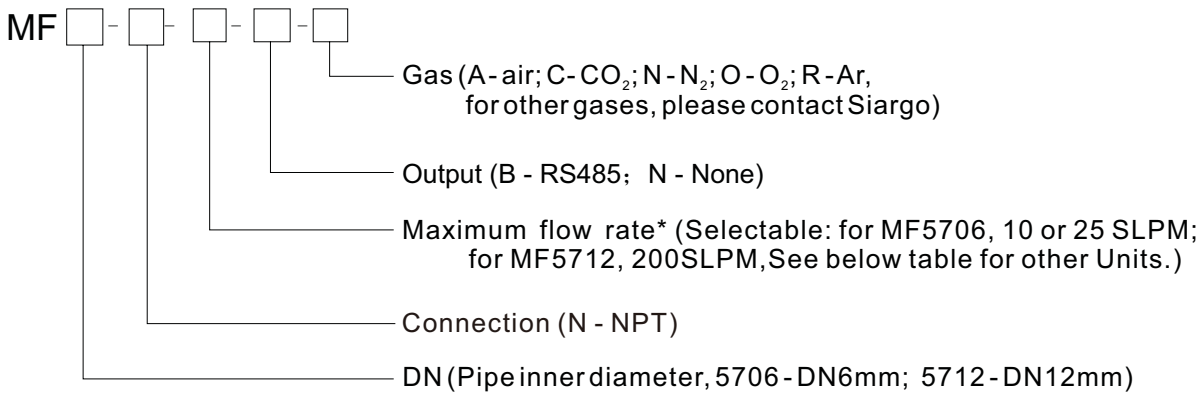

* There is flow rate number only for unit SLPM. If other unit is selected, there must be flow rate number with unit together. For CO₂, selectable: 10 or 20 SLPM (without 25 SLPM) for MF5706; 150 SLPM (without 200 SLPM) for MF5712.

Typical flow range:

Model	DN	Connection	Flow Range		
			SLPM	SCFM	NCMH
MF5706	6mm	1/4"	10	0.35	0.6
			25 (20)	0.88 (0.7)	1.5 (1.2)
MF5712	12mm	1/2"	200 (150)	7 (5)	12 (9)

Installation

The product at the time of shipment is fully inspected for product quality and meets all safety requirements. Additional safety measures during the installation should be applied. This includes, but is not limited to leakage verification procedures, standard EDS (electrostatic discharge) precautions, DC voltage precautions, and heavy duty precautions. Other tasks such as calibration, part replacement, repair, and maintenance must only be performed by trained personnel. Upon requests, manufacturer will provide necessary technical support and/or training of the personnel.

Do not open the product cover or alter any part of the product. Any such actions will forfeit the terms of the warranty and cause the liability to any damages thereafter.

The product is preferably to be installed horizontally. Flow direction should be aligned with the arrow mark on the meter body. If the flow fluid may have particles or debris, a filter is strongly recommended to be installed upstream of the meter.

Please follow the following steps to complete the installation:

- a) Upon opening the package, the product physical integrity should be inspected to ensure no visual damage.
- b) Before installation of the product, please ensure that the pipe debris or particles or any other foreign materials are completely removed.
- c) Cautions during installation:
 - (i) It is preferably to first install the inlet end of the meter and then the outlet end of the meter; To ensure the measurement accuracy, an upstream straight pipe of length no less than 10DN and a downstream straight pipe of length no less than 5DN should be in place.

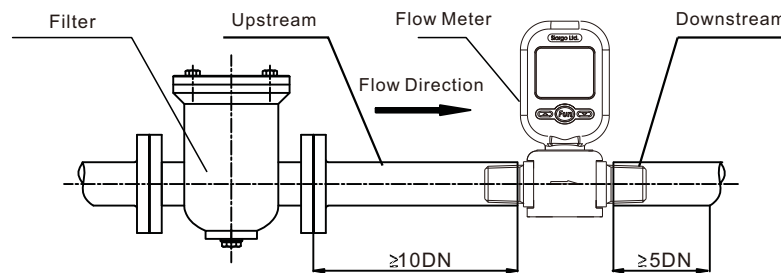

- (ii) If there is requirement of different pipe size at either upstream or downstream, the size of the pipe diameters should be larger than that of the selected meters. Please see detailed as below:

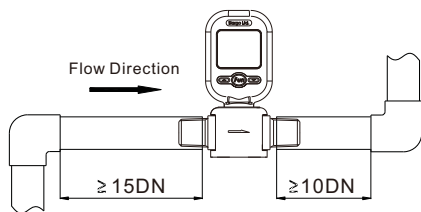

(a) 90 degree elbow or T-piece

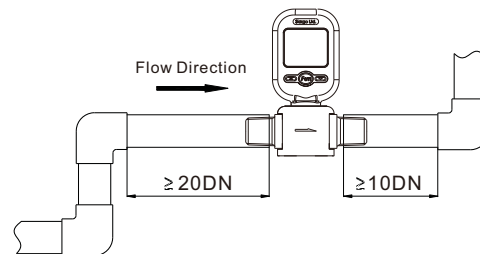

(b) 2 x 90 degree elbow

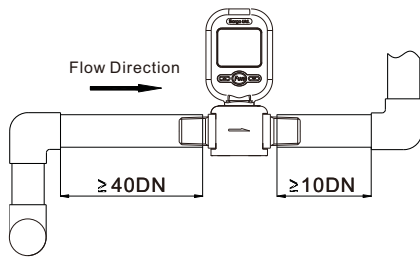

(c) 2 x 90 degree elbow, 3-dimensional

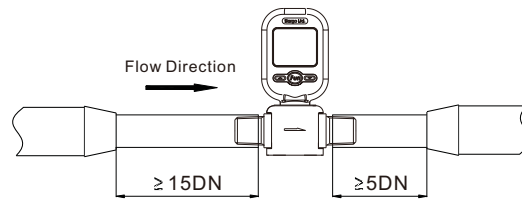

(d) Reduction

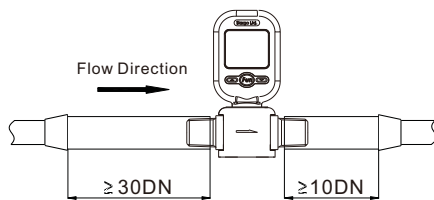

(e) Expansion

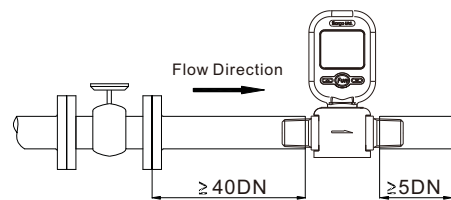

(f) Control valve

(iii) During installation, please make sure no any foreign materials (such as water, oil, dirty, particles, etc.) falling into the pipe.

- d) Connect electrical wires for LCD, and then electrical wires for inputs/outputs. Please pay special attention to power supply range (i.e., +5~+9 VDC) and power supply polarization (see the description on Electrical Interfaces in this manual).
- e) When connect the communication wires, please make sure that the wires are correctly connected to the proper ports on your data device/equipment.
- f) Turn on the power supply, and make sure that the LCD works correctly.
- g) Slowly open the valves at the both ends of the pipeline, and the meter should then start to measure the flow in the pipeline
- h) Completion of the installation.

Cautions

- a) Don't try to loose any build-in part of the product.
- b) Ensure electrical wires for the inputs/outputs to be reliably connected.
- c) Release all the installation stresses so that no stresses will be exerted on the product.
- d) The product should avoid strong electromagnetic interference sources nearby or periodic mechanical shocks to its body or pipeline.
- e) Slowly open/close valves to prevent abrupt pulse flow impact, which may damage the product.

Menu Operation

7.1 Interface illustration

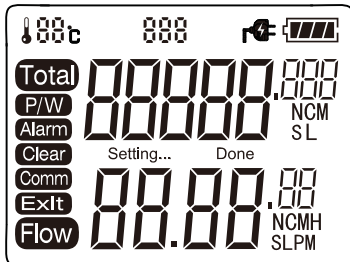

Interface includes *instant flow, accumulated flow; temperature and battery status; menu and other process data during setup.* See the graph at the left for details.

Three function keys on the front of the meter head:

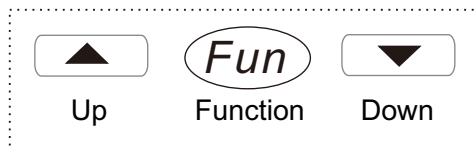



7.2 Operation

The following contents describe the details for each steps. Please read carefully before process.

7.2.1 Display at normal operation

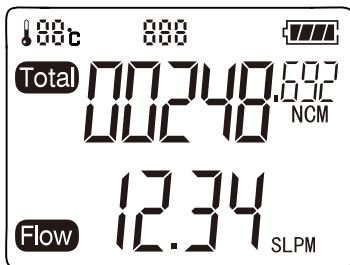
Upon power on, after self-check, the meter will come to the following display:





- a. Temperature: current temperature;
- b. Meter address: current protocol and address. The displayed address indicates remote communication is on. Otherwise, only local display is functional;
- c. Battery status: when this display turns into , the battery should be changed immediately or switch to external power;
- d. Total or accumulated flow: NCM or SL
- e. Instant flow: SLPM or NCMH

If the display is normal, pressure the *function key* **Fun**, it will enter into the password interface. Refer to 7.2.2 for password verification function. Once the password is correctly input, other interfaces will display.

7.2.2 Password verification

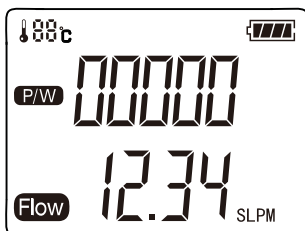
At the normal operation display, press **Fun** key, one can enter into password verification interface. Input the correct password, the *Setup Menu* will display. If the password is incorrect, the display will not change. For the first time use, the factory password is 11111.



To enter the password, press  or  key to change the digit when it flashes, and press **Fun** to confirm the enter. Repeat this process for all 5 digits and the meter will enter into the menu interface.

Note: at the time of password input, the flow measurement will not be interrupted.

7.2.3 Meter menu

When the meter passed “password verification”, the following menu can be accessed:

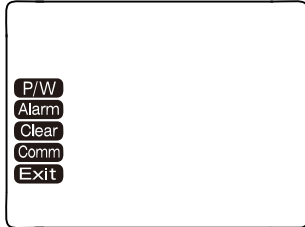

Press or to select the corresponding menu of desire. The selected menu will be flashing, press **Fun** to confirm the selection.

7.2.4 Change the default password

For data safety, it is advised that the default or factory set password should be changed at the first use of the product. (The factory preset password is 11111.)

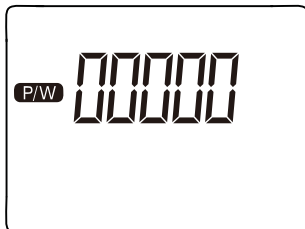

Press or to change the digit when it is flashing, and press **Fun** to confirm your enter.

It is advised that your password should be kept at a safe location and shall be recovered when it is needed. In case of password lost, please contact manufacture to obtain the special password for access of the meter.

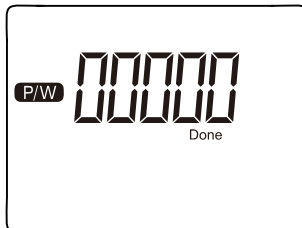
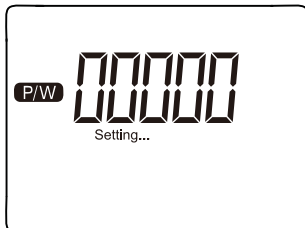

After the 5 digits are input completely, the interface will display “Setting...”. Please do not interrupt until “Done” appears on the screen. The process usually takes 3 seconds, and then it will automatically return to the menu selection screen.

7.2.5 Alarm setting

The alarm function allows the user to set the maximum accumulated flow or totalization of the flow. When the set value is reached and the flow is still accumulating, the alarm function will be triggered. The alarm is a sharp sound pulse at every 2 seconds with the whole screen flashing.

If the flow is ceased, the alarm will be switched off automatically. If any flow starts, the alarm will come back on. User can also disable the alarm by reset the value or switch off the flow.

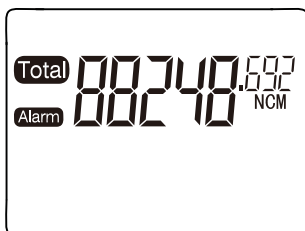

To set the 8 digit alarm value (maximum accumulated flow), please press either or to enter the desired value and press **Fun** to confirm the enter.

When the value is confirmed, the meter will start to save the value, and the process takes about 3 seconds, and the screen will show “Setting...”. Please do not interrupt until “Done” is displayed. The screen will then automatically return to the menu selection screen.

7.2.6 Reset the accumulation value

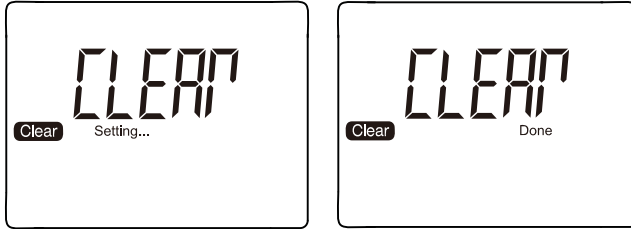

The function allows user to nullify the accumulated flow value. By selecting this menu (Clear), the accumulated flow will become zero. After press **Fun**, the screen will show "Setting...". Please do not interrupt until "Done" is displayed. The screen will then automatically return to the menu selection screen.

7.2.7 Communication menu

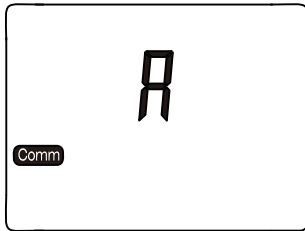

This function allows user to select single meter communication or communication network via RS485 (Modbus). After selecting this menu, the communication status is shown by the flashing letter at the center of the screen. **A** indicates single meter operation while **b** represents the Modbus networking status. Press **▲** or **▼** can change the current status to another. Then press **Fun** to confirm.

If your selection is **b**, after press **Fun** you will enter into the address selection menu as indicated below:

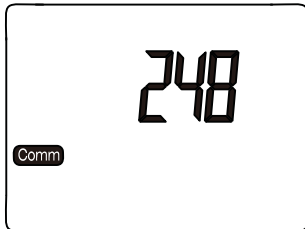

The meter address contains 3 digits, and can be any one from 001 to 255. Press **▼** or **▲** to change the digit when it flashes, and press **Fun** to confirm the change. After the last digit, the meter will start to save the changes that you have made. The process will take about 3 seconds and please do not interrupt the process until it shows "Done". The screen will automatically return to menu selection screen.

7.2.8 Exit

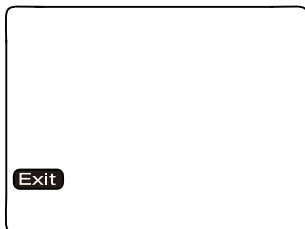

When all parameters are set as desired, select the "Exit" menu to exit and return to normal operation interface.

7.2.8 Button operation

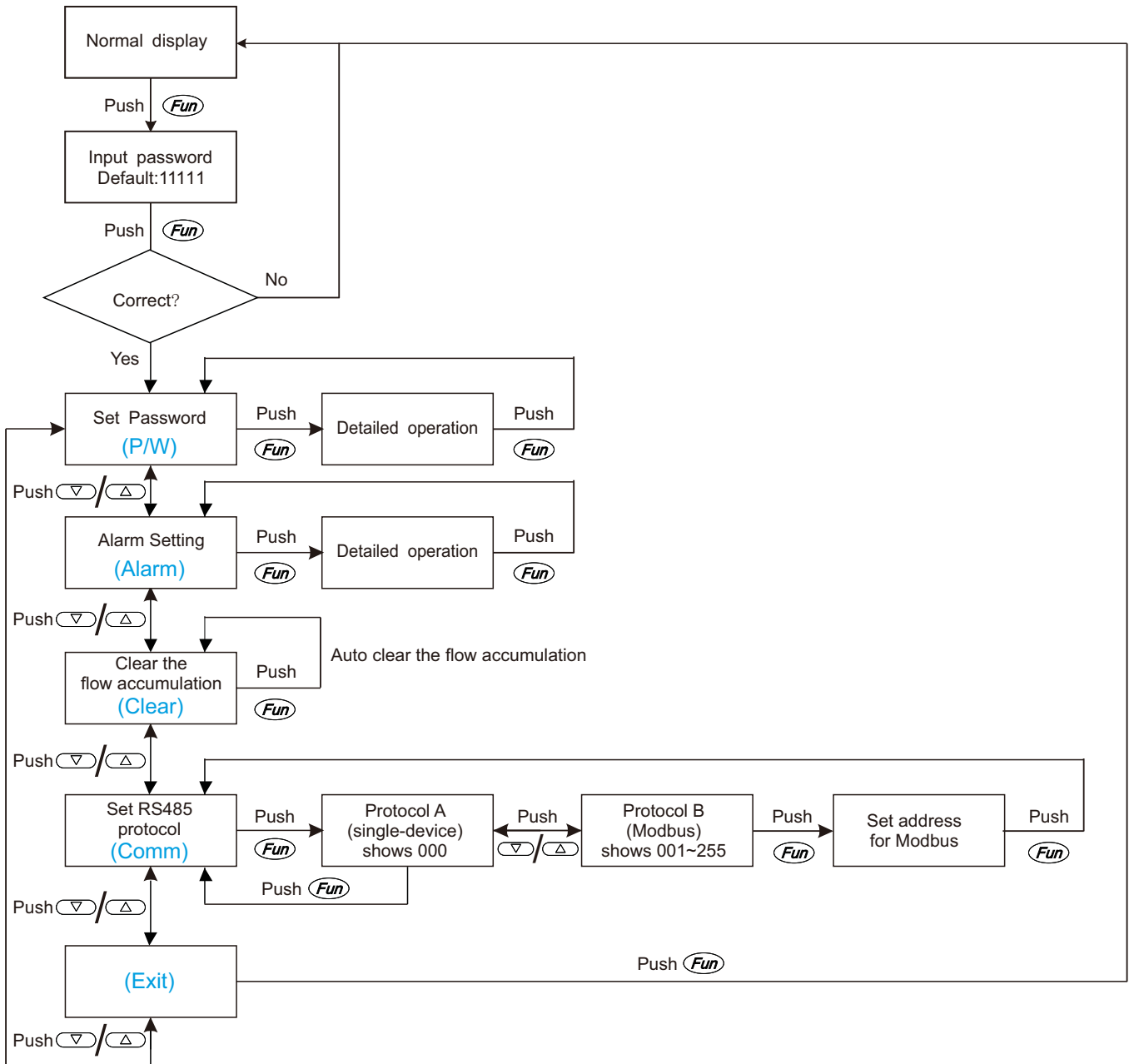

Communication

This product support RS485 Modbus protocol.

8.1 Cable definition

Cable	Name	Definition
Red	VCC	Power supply (6 ~ 15 VDC+)
Green	RS485A	RS485A
Brown	RS485B	RS485B
Blue	NC	Not connected
Black	GND	Power supply (-)

8.2 Communication port settings

Baud rate: 57600 bps (Protocol A) / 9600 bps (Protocol B)
 Data bits: 8 bits
 Stop bits: 1 bit
 Parity: None
 Flow control: None

8.3 Communication protocol

The meter supports two protocols. Protocol A can be used for single meter communications only while Protocol B is the standard Modbus.

8.3.1 Protocol A

Protocol A can only used for single meter communication and it can be used to access the meter via the communication port.

Digital communication mode: user can then access the digital data via the port:

- send 0x9d via RS485 and receive the same returned 9x9d;
- send 0x54 via RS485 and receive the same returned 9x54.

The meter will be at Digital communication mode at which the data from the meter will be sent via RS485 in an interval of 4 seconds. The data are in the following format:

S=sssss F=ffffff A=aaaaa.aaa T=tttt;\r\n

S=sssss Voltage code, variable length;

F=ffffff Mass flow rate, variable length (Equal to ffff.ff SLPM);

A=aaaaa.aaa Accumulated flow (Equal to aaaaa.aaa NCM), 3 decimal digits, variable integer digits.

T=tttt Gas temperature, variable length (Equal to ttt. °C)

Attention: there is a space before *F*, *A* and *T*.

Local display mode: use this mode when only LCD display is needed.

- send 0x9d via RS485 and receive the same returned 9x9d;
- send 0x00 via RS485 and receive the same returned 0x00.

8.3.2 Protocol B

Protocol B is based on the standard Modbus communication protocol. It supports either single meter communication or multi-meter networking. For detailed information, please contact the manufacturer.

Parts in Package

MF5700 mass flow meter	1	User manual	1
QC certificate	1	Connection cable (optional)	1
AC adapter	1		

Safety and Maintenance

10.1 Safety Precautions

The product is designed for use with general purpose gases such as air and nitrogen. It is advised that the products are best used for non-explosive clean gases. The sensors cannot be used for gas metrology of fluoride or fluoride containing gases. For updates of the product certification information, please contact manufacturer or visit www.Siargo.com. Use for other gases such as extreme corrosive and toxic may cause the product malfunctioning or even severe damages. The product sealing is ensured to work under working pressure of 0.8MPa and is leakage proof before the shipment. But cautions and further leakage test are important at installation as well since any leakage could cause severe safety issue. The power supply for this product is 5~12 VDC, all precautions and measures for electrical voltage handling must apply.

Attention: any alternation and/or improper use of the product without the permission of the manufacturer can cause unpredicted damages and even injuries or other severe situations. Siargo or any of its employees, subsidiaries shall not be hold and indemnified against such consequences due to such circumstances via improper use of the product.

10.2 Cautions for change of batteries

When the battery life indicator on LCD shows low, batteries should be changed immediately or switch to AC power. Do not allow battery leakage inside the meter.

10.3 Maintenance

Attention: without prior permission of the manufacturer, please do not attempt to alter any parts of the product as it may cause unrecoverable damages. If there are questions or doubts, please contact manufacturer immediately before further actions. Please ensure the DC power is off before disassembling the sensor.

All maintenance of the sensor should be done by trained and certified personnel by Siargo.